

Settings & Preferences

Press and hold the SEN and BRT buttons to access Preferences. To exit Preferences, simply wait a few seconds without pressing a button. The unit will display **Completed** to confirm your selections.

Press SEN to go from one category to the next

Press VOLUME + or - to change your setting within a category

User Mode	Advanced* Novice	Access and customize all Settings and Preferences Access and customize units and display color, (all other Settings are set to factory defaults) <i>NOTE: Switch back to advance mode to view all Preferences.</i>
Pilot	Scan Bar* Full Word	Scanning Bar with Full Word Full Word: Auto, Auto NoX, AutoLoK or Highway
Arrow Mode	Single* Multiple Band	Displays a single threat-direction arrow only for the primary alert Displays threat-direction arrows for multiple alerts Displays color-coded threat-direction arrows for multiple alert bands X = green, K = blue, Ka/Laser = red
Display Color	Blue*/Green/Red/Amber	Set color to match your vehicle's dash display
Speed Display	On* Off	Displays current speed Displays battery voltage
Cruise Alert	20 mph* Off / 20-160 mph	Offers double beep alert tones below specified speed
Over Speed	70 mph* Off / 20-160mph	Reminds you when you exceed a specified speed
Over Speed Limit	Speed Limit* Off / Speed Limit / 5 Over / 7 Over / 10 Over / 15 Over	Reminds you when you reach specified speed at or over the speed limit
Meter Mode	Standard Standard FR1* Standard FR2 Spec FR1 Spec FR2 Expert FR Simple	Displays primary alert band with front signal strength bar graph Displays primary alert band with front and rear signal strength bar graphs Displays primary and secondary alert bands with front and rear signal strength bar graphs Displays primary alert band with numeric frequency and front and rear signal strength bar graphs Displays primary alert band with numeric frequency, secondary alert band, and front and rear signal strength bar graphs Displays up to four alert bands with front and rear signal strength bar graphs for each Simple messages replace alert band and signal strength bar graphs: Caution (if traveling below cruise alert limit) Slow Down (if traveling above cruise alert limit)

Tones	Standard* Standard+	Standard alert tones Standard alert tones for primary alert and double-beep tones for additional alerts
	Mild	Mild doorbell chime alert tones
AutoMute	Low / Med* / High / Off	Automatically reduces audio to preferred volume during alert
AutoLearn	On* / Off	Automatically stores and locks out false alarms
Units	English* / Metric	Units for distance and speed
Language	English* / Espanol	Language for voice and text
Voice	On* / Off	Voice announcements
GPS Filter	On* / Off	Enables GPS-powered features
AutoPower	Off	Power turns on or off depending on your vehicle's ignition type (constant power or switched)
	1 Hour	Powers off automatically after 1 hour
	2 Hours	Powers off automatically after 2 hours
	4 Hours*	Powers off automatically after 4 hours
	8 Hours	Powers off automatically after 8 hours
		<i>NOTE: AutoPower only works with constant power ignition.</i>
		<i>NOTE: If AutoPower is on, to save screen life the display screen goes blank after 30 minutes without moving. Display screen will turn on automatically after you reach 10MPH.</i>
Band Enables	Default* Modified	Default Settings Band Enables have been modified from their default settings

Press BRT to go from one Band category to the next

Press VOLUME + or - to change your setting within a category

X Band	On* / Off			
K Band	On* / Off	Freq: 24.050 – 24.250 GHz		
		<i>NOTE: When K Band is off, you can select separate segments of the band to turn on or off.</i>		
KN1	On* / Off	Freq: 24.050 - 24.110 GHz		
KN2	On* / Off	Freq: 24.110 - 24.175 GHz		
KN3	On* / Off	Freq: 24.175 - 24.250 GHz		
KN4	On / Off*	Freq: 23.950 - 24.050 GHz		
Ka Band	On* / Off	Freq: 33.400-36.000 GHz		
		<i>NOTE: When Ka Band is off, you can select separate segments of the band to turn on or off.</i>		
KaN1	On / Off*	Freq: 33.400 - 33.700 GHz	KaN6	On / Off* Freq: 34.800 - 35.160 GHz
KaN2	On / Off*	Freq: 33.700 - 33.900 GHz	KaN7	On / Off* Freq: 35.160 - 35.400 GHz
KaN3	On* / Off	Freq: 33.900 - 34.200 GHz	KaN8	On* / Off Freq: 35.400 - 35.600 GHz
KaN4	On* / Off	Freq: 34.200 - 34.600 GHz	KaN9	On / Off* Freq: 35.600 - 35.840 GHz
KaN5	On* / Off	Freq: 34.600 - 34.800 GHz	KaN10	On / Off* Freq: 35.840 - 36.000 GHz
Ka-POP	On / Off*			
Laser	On* / Off			
TSR	On* / Off	Automatically rejects traffic flow sensors-monitoring false alarms		

Marker Enables	Default* Modified	Default Settings Marker Enables have been modified from their default settings
----------------	------------------------------------	---

Press BRT to go from one Marker category to the next

Other	On* /Off
Redlight	On* / Off
Red & Speed	On* / Off
Speed Cam	On* / Off
Speed Trp	On* / Off
Air Patrol	On / Off*

Press VOLUME + or – to change your setting within a category

Other location
Red light camera
Red light & speed camera
Speed camera
Speed trap
Known aircraft patrolled areas

NOTE: User cannot mark an air patrol location.

Clear Locations	Marked Lockouts Defender Format	Clear all user Marked locations. Press MUTE button to confirm Clear all lockouts. Press MUTE button to confirm Clear all DEFENDER data. Press MUTE button to confirm Clear DEFENDER database, all markers, and all lockouts Press MUTE button to confirm
-----------------	--	--

Wi-Fi	On* /Off	Turns Wi-Fi Connect on or off
-------	-----------------	-------------------------------

Bluetooth	On* / Off	Turns Bluetooth on or off
-----------	------------------	---------------------------

Auto Update	Off/Defender/ Software/All*	Automatically checks for selected updates when detector is powered on
-------------	------------------------------------	---

Perform Update	Defender Software	Perform Defender update. Press MUTE to confirm Perform Software update. Press MUTE to confirm
----------------	--------------------------	--

*Default Setting

Notes for Settings & Preferences

For descriptions of features and functions available when connected to ESCORT Live, visit EscortRadar.com and download the MAX 360c Owner's Manual.

To view serial number and software revision press MRK and MUTE while powering on detector.

To restore MAX 360c to its original factory Settings, press and hold MRK and BRT while turning the power on. A "Restored" message will display, acknowledging the reset.

Software Updates

In its factory default settings MAX 360c automatically receives software updates from your connected vehicle's Wi-Fi network. See **Using Wi-Fi Connect** on page 6 for connection instructions.

The MAX 360c operating firmware and red light and speed camera database can also be updated using a USB A/Mini B cable (not included) connected to a computer using our detector software tools found on our web site. In order to have access to these updates, please register your MAX 360c at www.EscortRadar.com

Warranty

ESCORT One Year Limited Warranty

What this warranty covers: Escort, Inc. ("Escort") warrants your Product against all defects in materials and workmanship.

For how long: One (1) year from the date of original purchase from an authorized Escort dealer.

What we will do: If a breach of warranty occurs, Escort, at its discretion, will either repair or replace your Product free of charge.

What we will not do: Escort will not pay shipping charges that you incur for sending your Product to us.

What you must do to maintain this warranty: Show original proof of purchase or receipt from an authorized Escort dealer.

Warranty exclusions: This warranty does not apply to your product under any of the following conditions: 1. The serial number has been removed or modified. 2. Your product has been subjected to misuse or damage (including water damage, physical abuse, and/or improper installation). 3. Your product has been modified in any way. 4. Your receipt or proof-of-purchase is from a nonauthorized dealer or internet auction site, including E-bay, U-bid, or other non-authorized resellers. 5. You are not the original purchaser of the Product from an authorized dealer or did not receive it as a gift from the original purchaser of the Product from an authorized dealer.

To obtain service: 1. Contact ESCORT (1-800-543-1608) to obtain a Return Authorization Number. 2. Properly pack your Product and include: your name, complete return address, written description of the problem with your Product, daytime telephone number, and a copy of the original proof of purchase or receipt. 3. Label the outside of the package clearly with your Return Authorization Number. Ship the Product pre-paid (insured, for your protection) to: ESCORT, Inc., 5440 West Chester Rd., West Chester, OH 45069.

LIMITATION OF WARRANTY: The obligations set forth above are ESCORT's sole obligations and your exclusive remedy. **ESCORT makes no other express warranty. Any implied warranty of merchantability or fitness for a particular purpose that may be applicable to the Product is limited in duration to the duration of this warranty.** Some States do not allow limitations on how long an implied warranty lasts, so the above limitation may not apply to you. **ESCORT SHALL NOT BE LIABLE FOR CONSEQUENTIAL, SPECIAL OR INCIDENTAL DAMAGES INCLUDING, WITHOUT LIMITATION, DAMAGES ARISING OUT OF THE USE, MISUSE OR MOUNTING OF THE PRODUCT.**

Some States do not allow the exclusion or limitation of incidental or consequential damages, so the above limitation or exclusion may not apply to you. ESCORT is not responsible for products lost in shipment between the owner and our service center.

Other legal rights: This warranty gives you specific legal rights, and you may also have other rights which vary from State to State.

©2017 ESCORT Inc. ESCORT® is a registered trademark of ESCORT Inc.

Contact Us

Accessories



800.433.3487



EscortRadar.com

Designed in the USA by Escort, Inc.,
Manufactured in the Philippines

ESCORT Inc.
5440 West Chester Road
West Chester OH 45069

Sales / Service 800.433.3487
www.EscortRadar.com

©2017 ESCORT Inc. ESCORT®, MAX 360c®, Defender®, AutoLearn®, TrueLock™, AutoSensitivity™, SpecDisplay™, ExpertMeter™, ESCORT Live™, IVT Filter™, SmartMute™ and EZ Mag Mount™ are trademarks of ESCORT, Inc.

FCC NOTE: Modifications not expressly approved by the manufacturer could void the user's FCC granted authority to operate the equipment.

FCC ID:OKLM6C.CONTAINS FCC ID:TFB-1003.

This device complies with part 15 of the FCC rules. Operation is subject to the following two conditions: (1) This device may not cause harmful interference, and (2) This device must accept any interference received including interference that may cause undesired operation.

ESCORT Live Compatible



The Bluetooth® word mark and logos are registered trademarks owned by Bluetooth SIG, Inc. and any use of such marks by ESCORT is under license.

Quick Reference

ESCORT MAX ^{360c}

360° Radar/Laser Detector with
Alert-Signaling Arrows

MAX 360c | Intelligent 360° Radar
Laser Detection



360° Directional
Alert Arrows



Connected Car's Wi-Fi
Provides Crowd Sourced
Alerts & Software Updates



GPS Intelligence
Rejects False Alerts



ESCORT Live App
Provides Crowd-
Sourced Alerts



Lightning Fast Response



360°
ALERTS

Congratulations



You've just purchased the MAX 360c with 360° directional arrows, GPS-based intelligence, plus Bluetooth® and Wi-Fi connectivity.

Go to EscortRadar.com for the full featured MAX 360c Owner's Manual.

Guía de Referencia Rápida Española traducida y manual con todas las funciones también son disponibles a www.EscortRadar.com

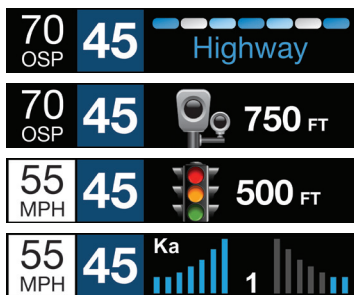

MAX 360c features a new multi-color OLED display. Brilliant graphics illuminate intuitive icons that identify the type of threat at a glance.

MAX 360c Features

- Front and rear radar receivers offer 360° ticket protection.
- Threat direction arrows report the direction an alert is coming from.
- MAX 360c's GPS location-based intelligence automatically locks out false alerts and allows you to mark locations for future reference.
- Using Wi-Fi, MAX 360c gives you wireless access to ESCORT's DEFENDER Database, which warns you of verified speed traps, speed cameras, and red light cameras.
- MAX 360c with built in Bluetooth® and Wi-Fi technology, gives you access to ESCORT's award-winning app, ESCORT Live. Our exclusive real-time ticket-protection network which warns you of upcoming alerts received and reported by other users in the area, and gives you access to local speed limit data for over-speed alerts.



Live Ready!

360° INTELLIGENT LONG-RANGE
RADAR-LASER DETECTION



Registration and ESCORT Live

Before downloading ESCORT Live, you must first register your device. Be sure to have your device nearby, as you will need its serial number.

- 1 Visit www.EscortRadar.com and click Product Registration.
- 2 Click the "Registration for all devices" link.
- 3 Follow the onscreen instructions to register your device.

Be sure to write down the username and password you create, as you will need this information to access and download ESCORT Live. (You will also receive an e-mail with this information, once you have registered your device.)

For iPhone:

- 1 Ensure MAX 360c power is ON 
- 2 Open the App Store on your iPhone and search for **ESCORT Live Radar**.
- 3 Follow the onscreen instructions to download **ESCORT Live Radar** and then open the app.
- 4 When prompted, enter the username and password you created when registering your product at EscortRadar.com.
- 5 Press the Settings button  then select **Devices**.

- 6 You should see **MAX 360c** listed with Not Connected underneath.

Press the **MAX 360c** device entry and when prompted select Pair.

- 7 The Bluetooth icon on the MAX 360c display will appear to confirm that it is paired to your iPhone.

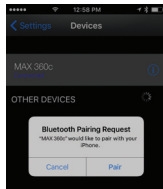

For Android based smartphones:

- 1 Ensure MAX 360c power is ON.
- 2 On your smartphone go to Bluetooth® Settings and make sure that Bluetooth® is ON.
- 3 Press Scan for devices and wait for the device list to populate, **MAX 360c** Live should appear under Available devices.
- 4 Press the **MAX 360c** device entry.
- 5 The Bluetooth icon on the MAX 360c display will appear to confirm that it is paired to your smartphone.
- 6 Open Google Play on your smartphone and search for **Escort Live Radar**. 
- 7 Follow the onscreen instructions to download **Escort Live Radar** and then open the app.
- 8 When prompted, enter the username and password you created when registering your product at EscortRadar.com.
- 7 Open the app, walk through the tutorial, and you're ready to hit the road!

Installation

Your new detector comes with our latest **EZ Mag Mount™**. Simply tilt the display end of the detector up and slide it onto the mounting bracket. The magnetic mount holds the detector in place. To remove the detector from the mount, simply lift the display end of the detector and the detector releases from the mount.

Mounting Tips:

- Center of windshield between driver and passenger.
- Ensure clear view of road ahead and sky above.
- Avoid windshield wipers and heavily tinted areas.

To mount the detector in your vehicle:

- 1 Remove paper backing from EZ Mag Mount™ StickyCup.
- 2 Ensure the locking clamp is open.

- 3 Firmly press EZ Mag Mount™ StickyCup onto windshield and close the locking clamp to secure.
- 4 To adjust view, loosen thumb wheel and adjust angle of mounting bracket. Tighten thumb wheel to secure.
- 5 Tilt the display end of the detector slightly upward and engage with the flanged edge of the mounting bracket. The EZ Mag Mount™ magnet holds the detector in place.
- 6 To remove the detector, simply lift the display end of the detector upward. The detector will release from the mount.
- 7 To remove mount from windshield, release locking clamp and pull tab on top of StickyCup.

EZ Mag Mount™ Care Instructions:

Should the EZ Mag Mount™ StickyCup accumulate debris and lose its stickiness, simply rinse under warm water, gently wipe off debris and allow to air dry.

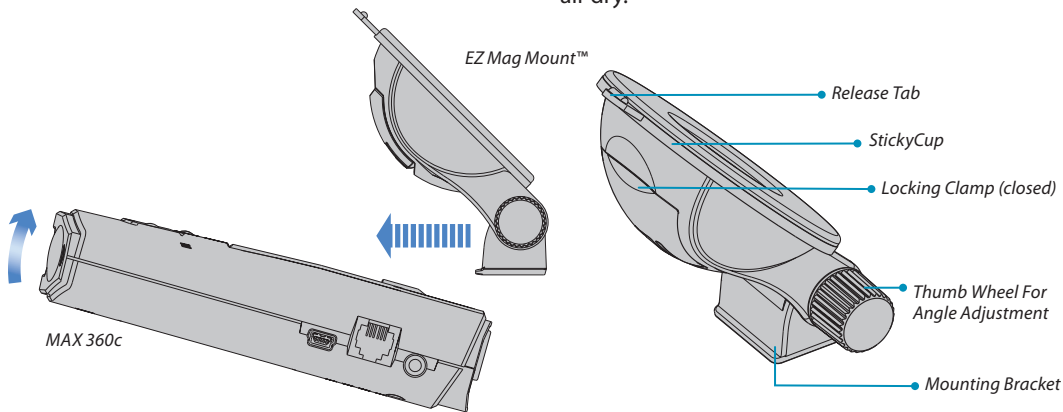

Controls & Features

Using MAX 360c

- 1 Plug small end of SmartCord USB into modular jack on MAX 360c and large end of SmartCord USB into your car's lighter/accessory socket.
- 2 MAX 360c should power on automatically. If not, press the device's power button. 

Using Wi-Fi Connect

To connect MAX 360c to your connected vehicle's Wi-Fi network.

- 1 Follow the directions on page 3 to register your MAX 360c, download the ESCORT Live app and pair the MAX 360c to your smartphone.
- 2 In the ESCORT Live app press Settings, select **Wi-Fi Settings** then **Connect to Wi-Fi Network**.
- 3 Enter your connected vehicle's Wi-Fi network password.

After successfully connecting and when powering up, MAX 360c will briefly display the connected Wi-Fi network's name. The speed limit indicator will be white when receiving Escort Live data from Wi-Fi (see page 6).

Earphone Jack

Connects to optional 3.5 mm stereo earphone

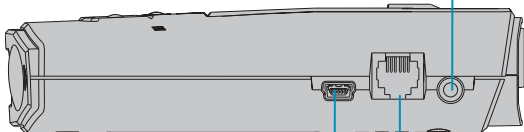

Mini USB Jack

Connects to your computer via USB A / Mini B cable for downloading software updates

Modular Jack

Connects to SmartCord USB for powering your device

Using SmartCord USB

• Mute Button:

- Press to mute the audio for a specific alert.
- Press three times to lock out a false alert.
- Press twice while receiving a locked-out alert to unlock.
- When connected to ESCORT Live press and hold mute button on unit or cord to manually report to other users a verified X or K-band alert, or a police officer observing traffic.

• **Alert Light:** Blinks red when receiving a radar or laser alert.

• **Power Light:** Lights green when receiving power.

• **USB Charging Port:** Charge smartphones, tablets and other USB-charged Devices.



Modular Connector
Plugs into detector jack

SmartCord USB Adapter

Connects to lighter/accessory socket

Controls & Features

